

# Matala Piston Compressor (MPC) Aeration System

---

## 115V/60Hz

- MPC-60 1/4HP 226W
- MPC-120 1/2HP 433W
- MPC-200 3/4HP 597W

## 230V/50Hz

- MPC-60 1/4HP
- MPC-120 1/2HP
- MPC-200 3/4HP

## Instruction and Maintenance Manual

### Introduction

---

Thank you for selecting the Matala Piston Compressor (MPC) Aeration System.

This instruction manual explains the product operations and gives important precautions regarding its safe use. In order to use the product to maximum benefit, be sure to read the instructions thoroughly and follow them carefully.

To avoid accident, do not use the compressor in any way other than as described in this instruction manual especially when you see **! WARNING**. After reading this instruction manual, keep it nearby as a reference in case questions arise during use.

If this instruction manual should become lost or damaged, ask your nearest dealer or representative for another copy.

## Contents

✓	<b>Construction and Parts List.....</b>	<b>2-3</b>
✓	<b>Warning .....</b>	<b>4-5</b>
✓	<b>Specifications .....</b>	<b>5</b>
✓	<b>Installation .....</b>	<b>6</b>
✓	<b>Electrical Wiring .....</b>	<b>6</b>
✓	<b>Warranty .....</b>	<b>6-7</b>
✓	<b>Maintenance .....</b>	<b>7</b>
✓	<b>Troubleshooting .....</b>	<b>7</b>

## Construction and Parts List

ITEM	PARTS	MPC-60CC1	MPC-120CC1	MPC-200C1-3
A	Power coated iron enclosure	1	1	1
B	Plastic base	1	1	1
C	1 Mini-Compressor	1	1	1
	2 NUT	4	4	4
	3 Anti-Vibration Mountings	4	4	4
	4 Flat washers	4	4	4
	5 Prevailing torque hex nuts	4	4	4
	6 Oil-filled Gauges	1	1	1
	7 Swivel Adapter	1	1	0
	8 90° Male Elbow	1	1	1
	9 Manifold Base	1	0	0
	10 Silencer	1	1	1
	11 Hexagon socket pipe plugs	0	1	1
	12 Pressure relief valve	1	1	1
	13 Ball valve	2	3	3
	14 Male Hose-Barb Elbow	2	3	3
	15 Stainless Steel Hose Clamps	4	6	6
	16 Air Pressure Hose	2	3	3
	17 Union	2	3	3
	18 Adapter	1	0	0
	19 Street Elbow	0	1	0
	20 Street Elbow	0	1	1
	21 Swivel Adapter	0	0	1
D	Draw latch	1	1	1
E	Air-Flow Fans	1	1	1
F	1 Plastic Corrugated Tubings	1	1	1
	2 Fans Power Line	1	1	1
	3 Fans Ground Line	1	1	1
G	1 Aluminum Box	1	1	1
	2 GFI	1	1	1
	3 Cable Glands	1	1	1
	4 90° Cable Glands	1	1	1
H	Power Line	1	1	1
I	Pull-out Carrying Handle	2	2	2

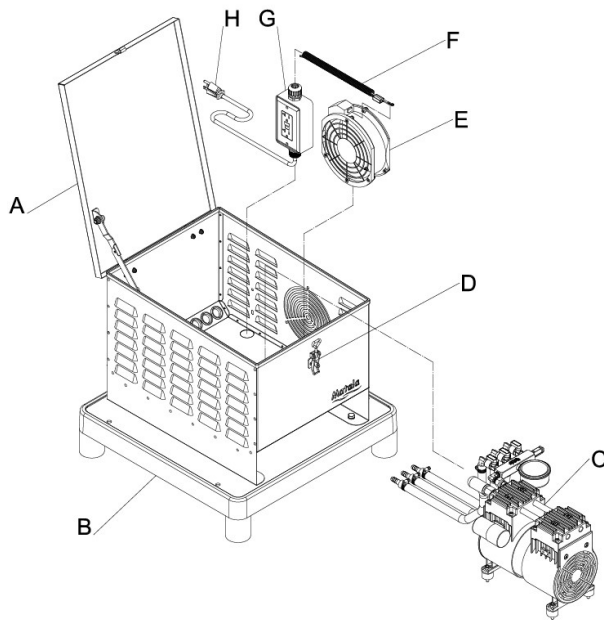

**C: MPC-60C1**

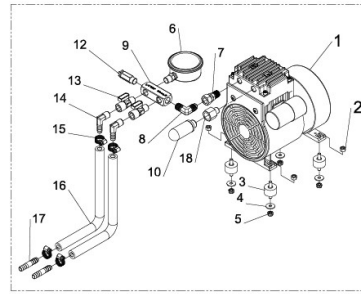

**C: MPC-120C1 / MPC-200C1-3**

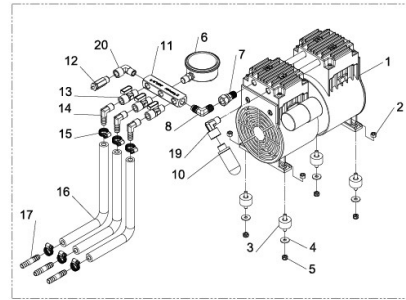

ITEM	PARTS	MPC-60C2	MPC-120C2	MPC-200C1-4
A	Power coated iron enclosure	1	1	1
B	Plastic base	1	1	1
C	1 Mini-Compress	2	2	1
	2 NUT	8	8	4
	3 Anti-Vibration Mountings	8	8	4
	4 Flat washers	8	8	4
	5 Prevailing torque hex nuts	8	8	4
	6 Oil-filled Gauges	2	2	1
	7 Swivel Adapter	2	2	0
	8 90° Male Elbow	2	2	1
	9 Manifold Base	2	0	1
	10 Silencer	2	2	1
	11 Hexagon socket pipe plugs	0	2	1
	12 Pressure relief valve	2	2	1
	13 Ball valve	4	6	4
	14 Male Hose-Bard Elbow	4	6	4
	15 Stainless Steel Hose Clamps	8	12	8
	16 Air Pressure Hose	4	6	4
	17 Union	4	6	4
	18 Adapter	2	0	0
	19 Street Elbow	0	2	0
	20 Street Elbow	0	2	0
	21 Swivel Adapter	0	0	1
	22 Hexagon socket pipe plugs	0	0	2
	23 Nipple	0	0	1
D	Draw latch	1	1	1
E	Air-Flow Fans	1	1	1
F	1 Plastic Corrugated Tubings	1	1	1
	2 Fans Power Line	1	1	1
	3 Fans Ground Line	1	1	1
G	1 Aluminum Box	1	1	1
	2 GFI	1	1	1
	3 Cable Glands	1	1	1
	4 90° Cable Glands	1	1	1
H	Power Line	1	1	1
I	Pull-out Carrying Handle	2	2	2

**C: MPC-60C2**

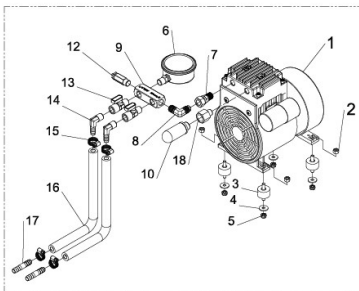

**C: MPC-120C2 / MPC-200C1-4**

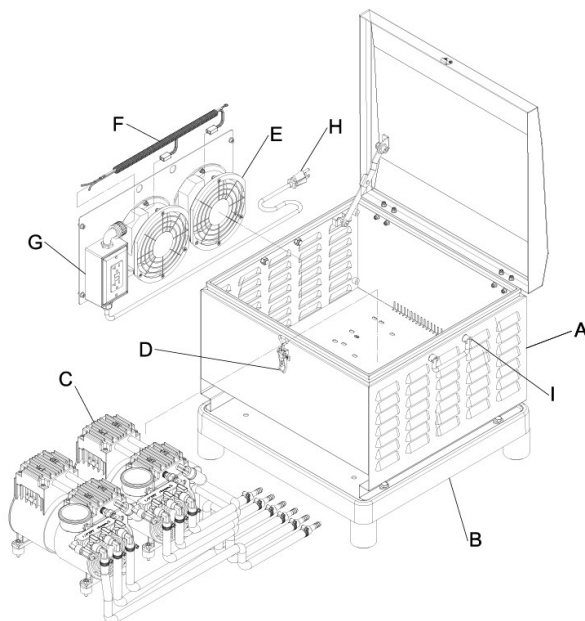
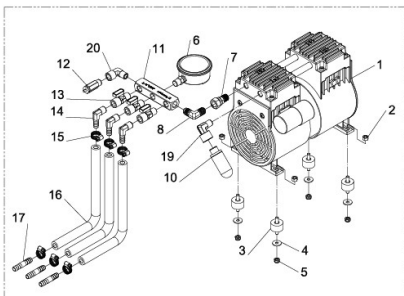

## Warning

IMPORTANT SAFEGUARDS READ AND FOLLOW ALL SAFETY INSTRUCTIONS.

### DANGER

To avoid possible equipment electric shock, special care should be taken when the compressor is used as aeration equipment. For each of the following situations, do not attempt to repair yourself, return the compressor to an authorized service facility servicing, or discard the compressor.

- I) If the compressor falls into the water, DO NOT REACH FOR IT: first unplug the compressor, and then retrieve it.  
If the compressor's electrical components get wet, unplug the compressor immediately.
- II) Carefully examine the compressor after installation. It should not be plugged in if there is water on parts that are not intended to be wet.
- III) Do not operate if the cord or plug is damaged, or if the compressor is malfunctioning, dropped, or damaged in any way.
- IV) To prevent the plug of electrical outlet from getting wet, position the water tank and stand to one side of a wall mounted outlet.

This should prevent water from dripping onto the plug or outlet.

A drip loop shown in the (Figure 1), should be arranged for each cord connecting the compressor to an electrical outlet. The drip loop is that part of the cord below the level of the outlet or connector if an extension cord is used. The drip loop prevents water traveling along the cord and going into the outlet.

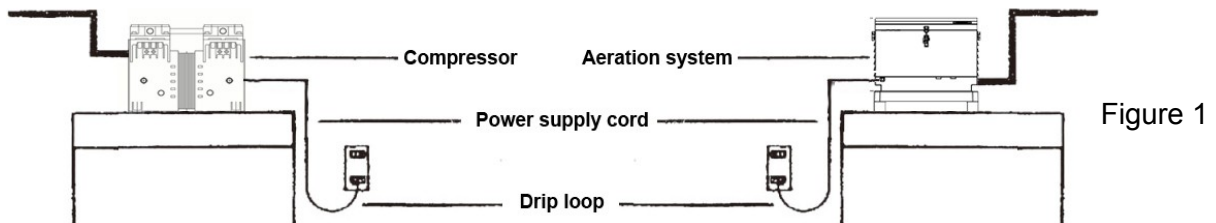

If the plug and outlet does get wet, DO NOT UNPLUG THE CORD: Disconnect the fuse or circuit breaker supplying power to the compressor. Then unplug and examine for the presence of water in the outlet.

- V) Do not use the compressor near volatile liquid such as gasoline, thinners, etc, as this creates the possibility of an explosion.

### CAUTIONS FOR USE

- A) Close supervision is necessary when an appliance is used or near children.
- B) This compressor is air-operated. Do not, under any circumstances, attempt operation with water or other liquids, otherwise compressor may be damaged.
- C) The temperature range may result in malfunction of severely shortened service life.
- D) Do not block the air being discharged. Compressor must have sufficient room to allow for heat dissipation.

Under the extreme operating temperature conditions which may be caused by failure to observe cautions C) or D), compressor will automatically switch off until cool. DO NOT REMOVE COMPRESSOR CASING UNTIL UNIT IS DISCONNECTED FROM MAIN SUPPLY.

- E) Always unplug compressor prior to servicing. Grasp plug to remove cord from outlet. Do not remove by pulling on power cord.
- F) Do not use the compressor for any other purpose other than its original intended application. Use of unauthorized replacement parts may jeopardize safety.
- G) Do not store compressor under freezing condition.
- H) Ensure compressor is securely mounted prior to operation.
- I) Read and observe all important markings on compressor.
- J) Ensure that extension cords (if required) have the correct or higher rating (amperes or watts). Ensure cord is properly positioned to prevent tripping or entanglement.

# Specifications

Check the nameplate for your compressor's specification as the table list.

Be careful not to exceed the given specifications in the use of your compressor.

Other specifications are noted in the chart below.

Model	MPC-60C						MPC-120C						MPC-200C											
Specification / order	MPC-6016C		MPC-6026C		MPC-6025C		MPC-12016C		MPC-12026C		MPC-12025C		MPC-20016C-3		MPC-20026C-3		MPC-20025C-3		MPC-20016C-4		MPC-20026C-4		MPC-20025C-4	
Components	Includes oil filled pressure gauge. Pressure relief valve, 2 or 3 way valve aluminum manifold with swivel union, heat-resistant tube.																							
HP	1/4						1/2						3/4											
Volt / Hz	115V/60Hz		220V/60Hz		230V/50Hz		115V/60Hz		220V/60Hz		230V/50Hz		115V/60Hz		220V/60Hz		230V/50Hz							
PSI	Ft.	M.	LPM	CFM	LPM	CFM	LPM	CFM	LPM	CFM	LPM	CFM	LPM	CFM	LPM	CFM	LPM	CFM	LPM	CFM	LPM	CFM	LPM	CFM
0	0	0	110	3.89	108	3.81	98	3.46	156	5.51	155	5.47	135	4.77	212	7.49	218	7.70	186	6.57				
5	11.5	3.5	98	3.46	93	3.28	80	2.83	141	4.98	146	5.16	125	4.42	204	7.21	205	7.24	178	6.29				
10	23.1	7.0	92	3.25	89	3.14	78	2.75	138	4.87	140	4.94	118	4.17	195	6.89	195	6.89	168	5.93				
15	34.6	10.5	89	3.14	84	2.97	70	2.47	129	4.56	135	4.77	113	3.99	192	6.78	190	6.71	160	5.65				
20	46.1	14.1	83	2.93	77	2.72	69	2.44	120	4.24	129	4.56	108	3.81	182	6.43	180	6.36	158	5.58				
25	57.7	17.6	79	2.79	75	2.65	65	2.30	115	4.06	122	4.31	100	3.53	176	6.22	171	6.04	150	5.30				
30	69.2	21.1	76	2.68	71	2.51	61	2.15	102	3.60	110	3.89	95	3.36	170	6.00	167	5.90	147	5.19				
40	92.3	28.1	69	2.44	62	2.19	53	1.87	91	3.21	100	3.53	87	3.07	159	5.62	158	5.58	130	4.59				
50	115.3	35.2	64	2.26	50	1.77	46	1.62	79	2.79	90	3.18	78	2.75	142	5.02	142	5.02	120	4.24				
Amp at 0psi	2.2		1.0		1.0		3.0		1.6		1.5		5.4		3.1		2.5							
Amp at 20psi (46.1ft./14.1m)	3.2		1.6		1.7		4.0		2.2		1.9		6.9		3.7		3.0							
Watt(input) at 0psi	231W		213W		191W		332W		330W		290W		594W		619W		515W							
Watt(input) at 20psi (46.1ft./14.1m)	339W		333W		315W		455W		464W		416W		768W		777W		651W							
Suggested pond size	1/4 ~1 Acre Lake (5~30 ft deep)						1/2~2 Acre Lake (8~40 ft deep)						Up to 4 Acre Lake (10~40 ft deep)											
Suggested tubing size (in) / (mm)	3/8"~5/8" / 9.5~15.9 (suggest max.100ft)						3/8"~5/8" / 9.5~15.9 (suggest max.100ft)						3/8"~1" / 9.5~25.4 (suggest max.100ft)											
Dimensions :LxWxH (in) / (mm)	7.1x6.3x7.8 / 181x160x198						9.4x6.3x7.8 / 240x160x198						10.8x6.5x9.5 / 275x166x242											
Weight (lbs) / (kg)	18.5 / 8.4						22.9 / 10.4						29.3 / 13.3											
Aeration System	MPC-60C1		MPC-120C1		MPC-200C1-3		MPC-60C2		MPC-120C2		MPC-200C1-4													
Cabinet system components	Powder coated paint cabinet, cooling fan, GFI electrical box outlet, cabinet base.																							
Compressor model type	1xMPC-60C		1xMPC-120C		1xMPC-200C-3		2xMPC-60C		2xMPC-120C		1xMPC-200C-4													
Suggested pond size	1/4~1 Acre Lake 5~30 ft deep		1/2~2 Acre Lake 8~40 ft deep		Up to 4 Acre Lake 10~40 ft deep		1/2~2 Acre Lake 5~30 ft deep		1~4 Acre Lake 8~40 ft deep		Up to 8 Acre Lake 10~40 ft deep													
Dimensions:LxWxH with base (in) / (mm)	20.2x20.2x18.6 / 513x513x472						21x20.2x18.6 / 534x513x472																	
Weight with base (lbs) / (kg)	55.3 / 25.1		59.7 / 27.1		66.1 / 30.0		85.5 / 38.8		94.4 / 42.8		77.2 / 35.0													
Dimensions :LxWxH without base (in) / (mm)	19.5x15.1x14.2 / 495x384x362						21x19.5x14.2 / 534x495x362																	

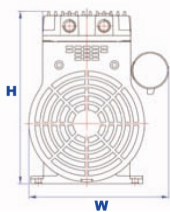

MPC-60

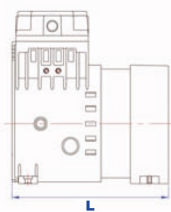

MPC-120/200

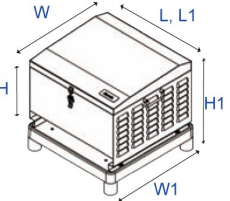
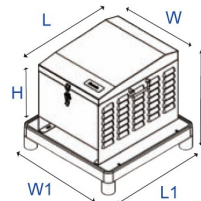
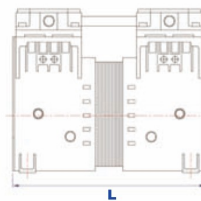
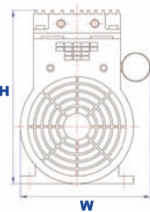

## **Installation**

---

Installation :

**! WARNING :** Do not work on compressor until power is unplugged.

Do not cut off ground pin or use an adapter fitting.

Do not use an extension cord

Accessories :

Check air filters periodically and replace when necessary. Install relief valve and gauges at inlet or outlet or both, to monitor performance. Check valves may be required to prevent back flow through compressor.

Plumbing:

Connect with pipe and fittings that are the same size or larger than threaded ports. Be sure to connect the intake and exhaust plumbing to the correct inlet and outlet ports.

Start Up:

If motor fails to start or slows down significantly under load, shut off and disconnect from power supply. Check that the supply voltage is correct and verify motor is turning in the proper direction. Check plug, cord and switch for damage. Thermal protection switch may have tripped, the motor will turn off until cool and then turn on again..

Start-up procedures:

**! WARNING :** The purpose of the Lake Aeration System is to circulate the pond's entire water. This circulation will increase and maintain oxygen levels and eliminate drastic temperature fluctuations. The efficiency of the Matala aeration system can initially create problems if the following start-up procedures are not followed. Improper start-up may result in an unintentional fish kill.

- Turn on the system and operate for 15 minutes.
- Turn off the system for the remainder of the day.
- Restart the system the next day and operate for 30 minutes.
- Turn the system off for the rest of the day.
- Each day double the operating time from the previous day until the system is running continuously. This should take approximately eight (8) days.



**! WARNING :** It is important to follow this start up procedure carefully. Every pond has bottom sediment. The quantity of sediment will vary in each lake depending on lake age and runoff from the surrounding area. This sediment can contain toxic or noxious chemicals and bacteria. When first installed, the Lake Aeration System may disturb this sediment and may disperse these toxins into the upper water layers of the lake causing fish disease or mortality. To prevent this possible problem, follow the daily 15 minute start up procedure above.

Alternatively, you may install the air diffusers 2 feet above the sediment so as not to disturb the sediment. Weekly lower the diffusers 6 inches closer to the sediment and observe the color change of the rising water. If the water color changes brown, black or muddy then follow the above daily 15 minute start up procedure again.

## **Electrical Wiring** \_\_\_\_\_

Electrical wire Connection :

**! WARNING :** Verify that the voltage and frequency of the electric pump shown on the nameplate correspond to those available on the mains.

The installer must make sure that the electric system is grounded in accordance with the law in force.

## **Warranty** \_\_\_\_\_

Limited Warranty :

Matala compressor will repair or replace for the original user any portion of a new compressor product which proves defective due to materials or workmanship of compressor within 1 years of purchase date. Contact the nearest authorized compressor dealer for warranty service.

Matala compressor shall possess the sole right to determine whether to repair or replace defective equipment, parts or components.

THIS WARRANTY DOES NOT COVER DAMAGE DUE TO LIGHTNING OR OTHER CONDITIONS BEYOND THE CONTROL OF compressor.

LABOR & COSTS : Matala compressor shall in no event be liable for the cost of field labor or other charges incurred by any customer in removing and/or reaffixing any Matala compressor product, parts or component.

THE WARRANTY WILL NOT APPLY:

- (a) to defects or malfunctions resulting from failure to properly install, operate, or maintain the unit in accordance with printed instructions provided.
- (b) to failures resulting from abuse, accident, or negligence.
- (c) to normal maintenance services and the parts used in connection with such service. Such as Rebuild

Kit Components and Air Filters.

(d) to units which are not installed in accordance with applicable local codes, ordinances, and good trade practices.

(e) if unit is used for purposes other than for what it was designed and manufactured for.

(f) if unit or components have been tampered with or modified in any way by an unauthorized dealer or repair shop.

WARRANTY EXCLUSIONS : Matala compressor

SPECIFICALLY DISCLAIMS THE IMPLIED WARRANTIES OF MERCHANTABILITY AND FITNESS FOR A PARTICULAR PURPOSE AFTER THE TERMINATION OF THE WARRANTY PERIOD.

## **Maintenance** \_\_\_\_\_

**NOTE: Before performing any maintenance and troubleshooting, unplug the system and wait for the compressor to cool down.**

Keep cabinet air inlets and outlets free of debris and weed growth for proper ventilation.

If the System Does Not Operate:

- Press and re-set the GFCI electrical receptacle located inside the cabinet.

Air Filter Cleaning / Replacement:

- Unscrew the filter from the compressor; clean with soapy water, dry completely and replace.

Check Diffusers for Material Build Up or Damage:

- The diffusers located on the MDB(Matala Diffuser Base) may have been damaged or blocked by material build up (after a long period of inactivity). Inspect that the membranes are clear with no rips or holes. Clean or replace as necessary.

Piston Rebuild Kit:

- Rebuild kits are available by contacting Matala or your distributor. Under proper installation and conditions, a rebuild should not be required for up to 1~2 years of normal operation.

## **Matala Rocking Piston Compressor Rebuild Kit Instructions**

1. Use a Phillips head screw driver to unscrew the Cooling Fan Cover Screw (part no. 20)

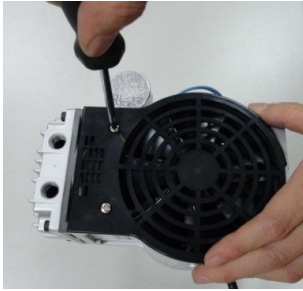

2. Use a flat head screw driver to open the Cooling Fan Cover (part no. 1)

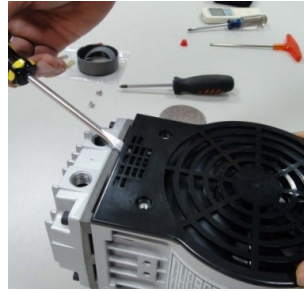

3. Use a 4mm hex wrench to unscrew the Head Cover Screw (part no. 19)

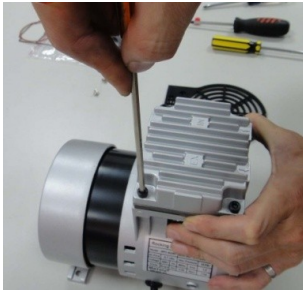

4. Open the Head Cover (part no. 18), take out the Valve Plate (part no. 16)

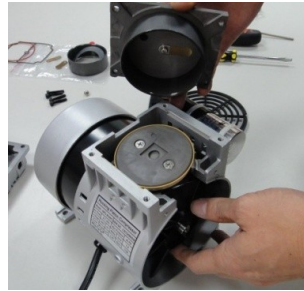

5. Use a Phillips head screw driver to unscrew the Round Plate Screw (part no. 10), Take out the Round Plate (part no. 9) & Piston Cup (part no. 8)



6. Replace the new Cylinder (part no. 11) in original position (*note : Convex Face Up*)



7. Assemble the new Piston Cup (part no. 8) & Round Plate (part no. 9)



8. Put the New Piston Cup (part no.8) & Round Plate (part no. 9) in original position



9. Hold the Cylinder in position & use a Phillips

10. Replace the new Cylinder O-ring (part no. 12)

head screw driver to tighten the Round Plate Screw (part no. 10)



11. Replace the new Valve O-ring (part no. 17)

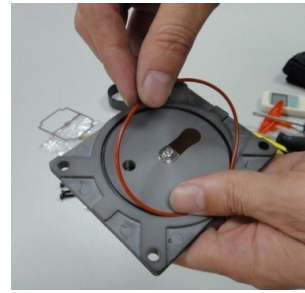

12. Remove the Screw that holds the Valve Fixed Strip (part no.31). Remove the Upper & Lower Valve Flappers. (part no. 15)

*(Note : part no.31 is not included in the rebuild kit.)*

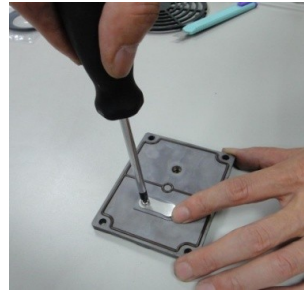

**13. Replace the new Valve Flappers (part no. 15)  
Included in your kit.**

**13-a**

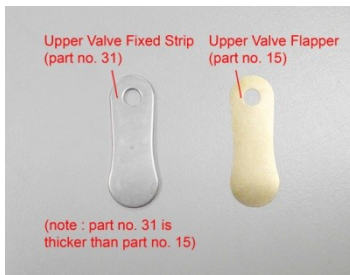

**13-b**



**14. Reposition the Valve Fixed Strip (part no. 31)  
and tighten the screw .**

*(Note : The Valve Fixed Strip and  
Valve Flapper need to be aligned)*



**15. Put on the Valve Plate (part no.16)**

*(Note : Cylinder O-ring & Cylinder need  
to be aligned)*



**16. Please note the relative position of the Valve  
Plate (part no.16) & Capacitor (part no.28)**

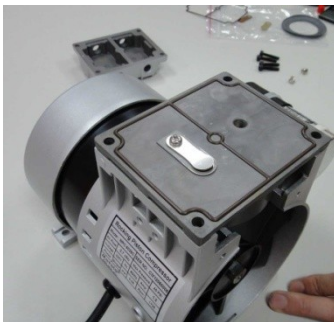

**17. Screw on the Head Cover (part no.18)**



**18. Replace the Cooling Fan Cover (part no.1)**

*(Note : the latch is on the bottom)*



**19. Screw on the Cooling Fan Cover**



# PARTS DIAGRAM

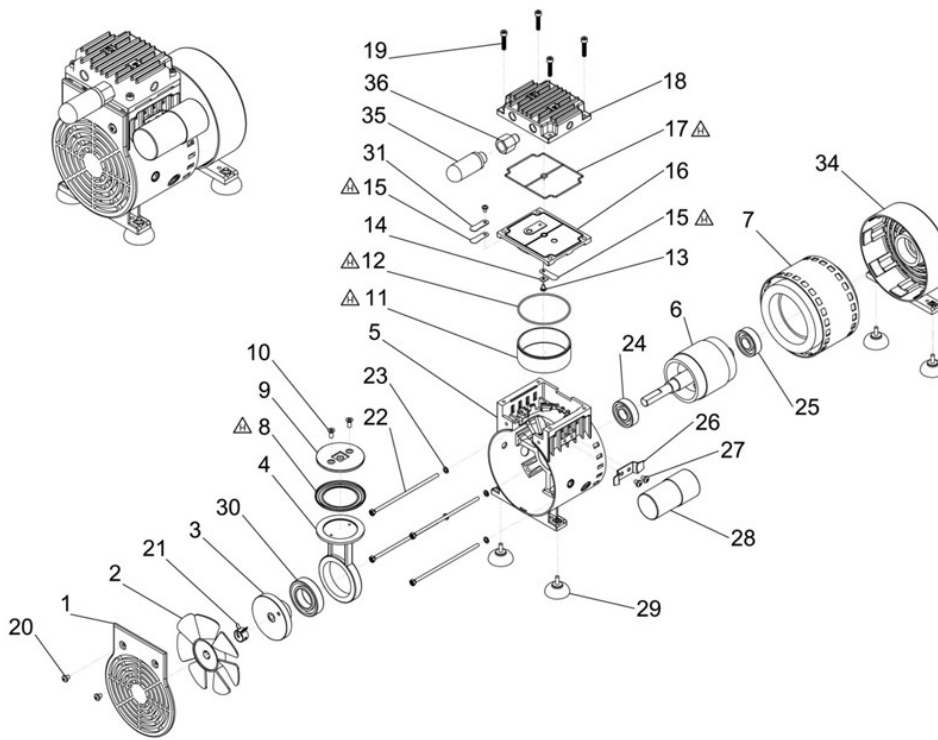

Aeration Systems ( MPC-60A)		
ITEM	PARTS	QTY
1	Cooling fan cover	1
2	Cooling fan	1
3	Eccentric	1
4	Piston rod	1
5	Housing	1
6	Rotor	1
7	Stator	1
8	Piston cup	1
9	Round plate	1
10	Countersunk Screw ( M5x10)	2
11	Cylinder	1
12	Cylinder O-ring	1
13	Screw M4x5	2
14	Down valve fixed strip	1
15	Upper/Down valve flapper	2
16	Valve plate	1
17	Valve O-ring	1
18	Head cover	1
19	Hex Head Bolt ( M5X25)	4
20	Pan Head Bolt ( M5X6)	2
21	Fixing clamp	1
22	Hex Head Bolt ( M5x135)	4
23	Spring washer ( M5)	4
24	Bearing 6203LLB	1
25	Bearing 6203LLB	1
26	Bracket	1
27	Pan Head Bolt ( M5X6)	2
28	Capacitor	1
29	Rubber foot ( M6)	4
30	Bearing 6006LLB	1
31	Upper valve fixed strip	1
32	Connecting tube	-
33	O-ring	-
34	Back cover	1
35	Silencer	1
36	Adapter	1

## Troubleshooting

Problems	Possible Cause	Remedy
Won't start	Filter dirty	Clean or replace
	Relief valve set too high	Inspect and adjust.
	Low voltage, won't start	Check power source.
	Leaky hose or check valve	Replace.
	Dirt or liquid on top of piston	Dirt or liquid on top of piston
	Plugged line	Inspect and repair
Compressor works but no air comes from reservoir or low pressure	Filter dirty	Clean or replace
	Leak hose or check valve	Replace
	Dirt or liquid on top of piston	Inspect and clean
	Valves dirty or bent	Clean or replace
	Relief valve set to low	Inspect and adjust
Over high pressure	Relief valve set too high	Inspect and adjust
	Plugged line	Inspect and repair
Compressor overheat	Filter dirty	Clean or replace
	Relief valve set too high	Inspect and adjust
	Plugged line	Inspect and repair
	Low voltage, won't start	Check power source
	Dirt or liquid on top of piston	Inspect and clean
Compressor works but produces loud, irregular noise	Filter dirty	Clean or replace
	Plugged line	Inspect and repair
	Low voltage, won't start	Check power source
	Worn cup/piston hitting cylinder	Replace

**Matala**<sup>®</sup>  
"Make water alive"